

2 Port 86 type Faceplate

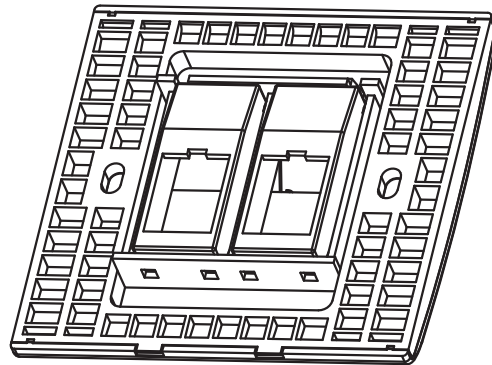
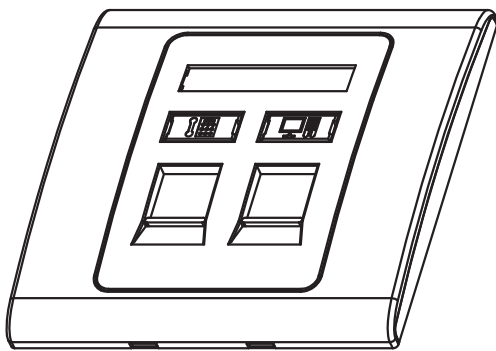
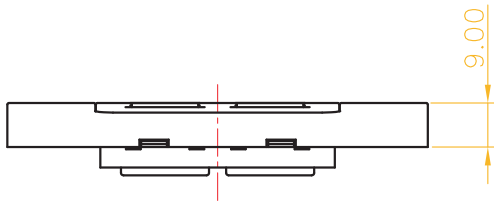
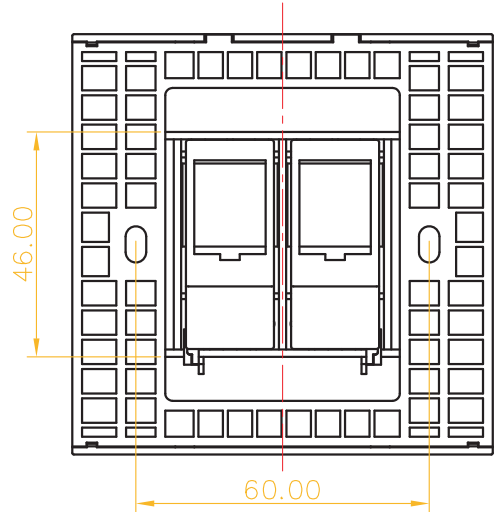
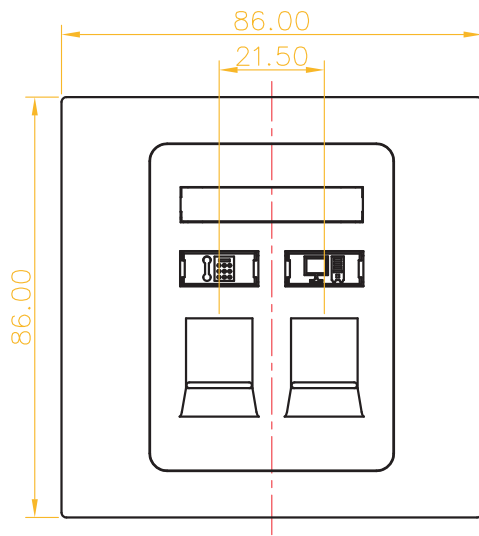

NOTE:

- 1.MATERIAL: FLAME RETARDANCY ABS UL94V-0
- 2.Retentiveness of insertion structure: 50N 60±5s
- 3.BURR: 0.05mm MAX